

1

2

3

4

A

A

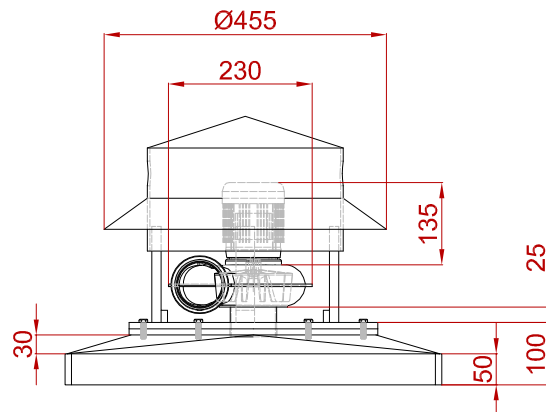
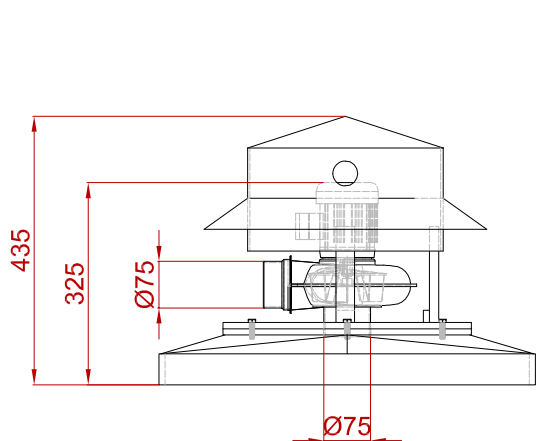

B

B

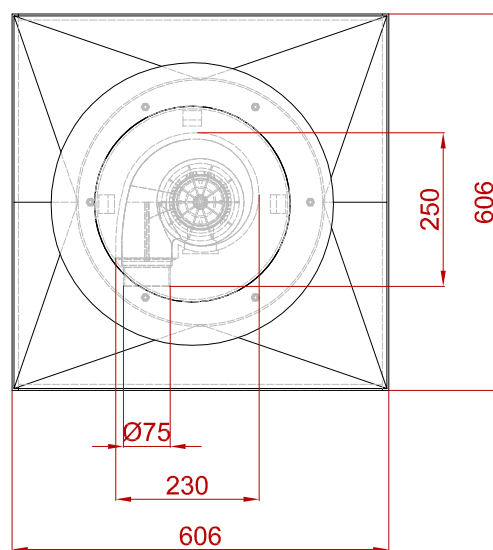
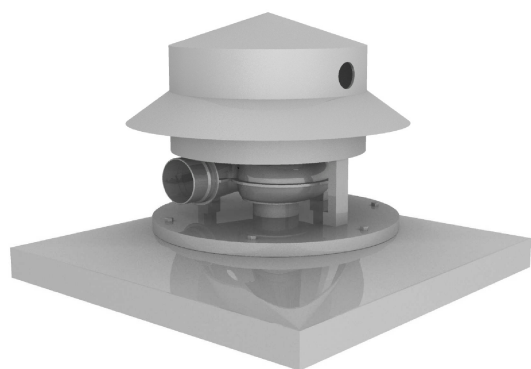

C

C

D

D

Ventilador M-75 Brida tejado

MATERIAL: PPH / PVC / PPEL-S
 REVOLUCIONES: 1500 rpm / 3000 rpm
 POTENCIA: 0,06 kW / 0,09 kW
 PROTECCIÓN: IP 55
 ALIMENTACIÓN: Trifásica / Monofásica

Fecha: 08.10.2020

Dibujado: IOC

Unidad: mm

Rev: 1

Quimipol
 J. BLANCH FERRER, S.L.

These drawings are the property of Quimipol, and can not be reproduced or copied in the whole of in part. It is only to be used for the project and site specifically identified here in and is not to be used in any other project. It is to be returned upon request.

1

2

3

4